



ESTRABINS SENSOR 26L

Apertura automática sin contacto



Por una vida más práctica

Nuevo

Integrante de la Familia **estrabins**



★ **ESTRABINS** **SENSOR 26L**

Presentamos el nuevo integrante de la **familia Estrabins**, un producto innovador, y practico que permite una apertura automática en las canecas, sin necesidad de entrar en contacto con ellas, minimizando el riesgo de infecciones.

Beneficios del producto



Material

Plástico 100% reciclable (polipropileno y ABS).

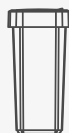

Diseño moderno



Aro sujetador de bolsa



No se oxida



Resistente a abolladuras



Liviana



Garantía 1 año



Fácil lavado



Cierre lento y silencioso



Apertura automática

Modos de uso



5 Sec

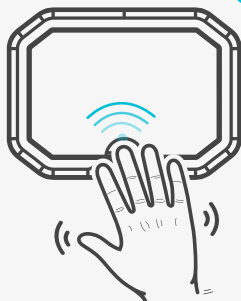

• Apertura sin contacto

Pase la mano cerca del sensor de la tapa. Ésta abrirá 5 segundos y se cerrará automáticamente.

• Apertura con el pie

Toque levemente con el pie la caneca. La tapa abrirá 5 segundos y cerrará automáticamente.



5 Sec

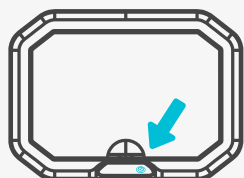

• Apertura manual

Toque el icono señalado en la pantalla de la tapa para abrir y vuelva a tocarlo para cerrarla.

Instrucciones de inicio

1.

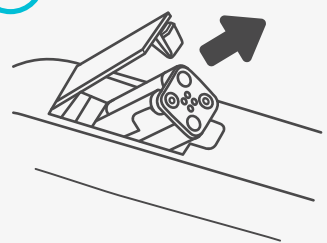

· Retire el soporte de las baterías.

2.

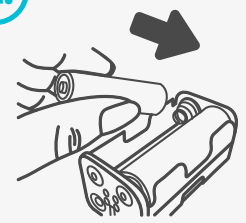

· Instale 3 baterías AA e ingrese el soporte asegurando buen contacto.

3.

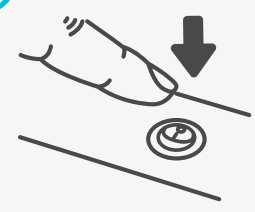

· Oprima el botón de encendido ubicado al lado de las baterías.

Dimensiones datos logísticos

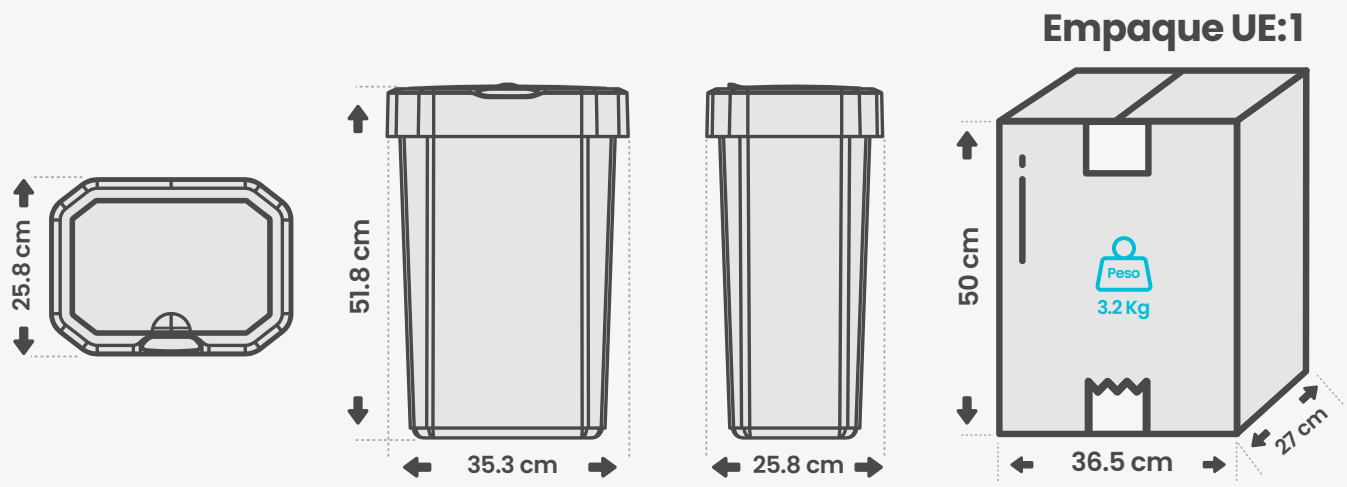

Referencias disponibles



4-1044719



4-1044720



4-1044725



4-1044718



4-1044723



4-1044724



4-1044721



4-1044722



4-1045013



4-1045014

Punto Ecológico Bins Sensor*
3 Puestos 26L Genérico:

4-1045015

Punto Ecológico Bins Sensor*
2 Puestos 26L Genérico:

4-1045016



Recomendaciones de uso



Lavado: Limpiar con un paño húmedo y jabón suave, no sumergir la tapa en agua.



Evitar colocar elementos pesados sobre la tapa.



Garantía de 1 año por daños de fabricación o uso normal del producto.



Al cumplir su vida útil se debe disponer en contenedor para residuos aprovechables.



Las pilas usadas se deben disponer en contenedores de residuos peligrosos.



Composición: Plástico 100% reciclable (Polipropileno y ABS).



Conoce más



Por una vida más práctica

Fabricado y comercializado por Industrias Estra S.A.
www.estra.com

Manizales 991-1, Lindavista Norte, Gustavo A Madero, CP 07300, CDMX Tel: 55 5119-1344 / 55 1055-6530 / atencion@comercialmontesur.com